

KIT

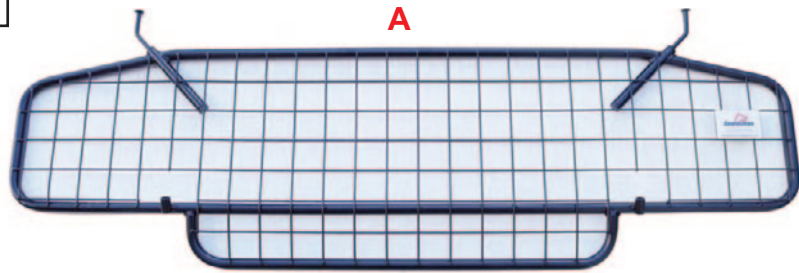

A



C x2

B x2
190mm

**READ FULLY BEFORE
BEGINNING -
IT'LL MAKE MORE SENSE!**

**VOR DEM ANFANG
VOLLSTÄNDIG
LESEN - ES WIRD MEHR
SINN MACHEN!**



**Range Rover L460
(2022 onwards)
G1633**

**DOG GUARD
FITTING INSTRUCTION**

**HUNDESCHUTZGITTER
EINBAUANLEITUNG**

**PROTECTION CONTRE LES CHIENS
INSTRUCTIONS DE MONTAGE**

**HUNDEGITTER
MONTERINGSVEJLEDNING**

**CONJUNTO PROTECTOR
PARA PERROS
INSTRUCCIONES DE MONTAJE**

**KIT BARRIERA CANI
ISTRUZIONI DI MONTAGGIO**

**HUNDEVERNGITTER
MONTASJEVEILEDNING**

**HONDENBESCHERMINGSREK
INBOUWINSTRUKTIES**

**SATS HUNDSKYDD
MONTERINGSANVISNING**

**KOIRAN TURVARISTIKKO
ASENNUSOHJEET**



RH&LH



A
Offer in Dog Guard - mesh to Back of Car
Grill auf der Rückseite des Autos



Manoeuvre the Guard into position
Manövrieren Sie die Hundegitter in Position



RH&LH

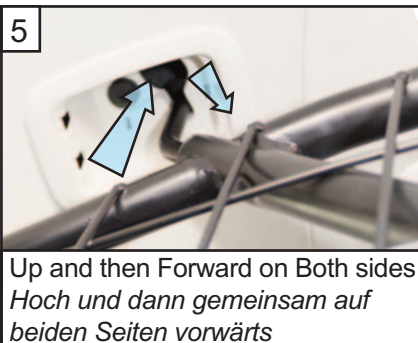

Up and then Forward on Both sides
Hoch und dann gemeinsam auf
beiden Seiten vorwärts

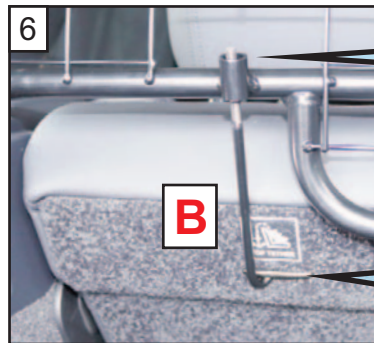

B

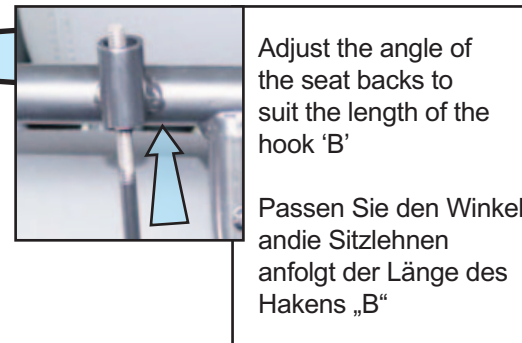
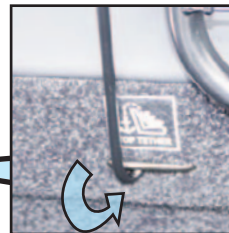

Adjust the angle of
the seat backs to
suit the length of the
hook 'B'

Passen Sie den Winkel
andie Sitzlehnen
anfolgt der Länge des
Hakens „B“

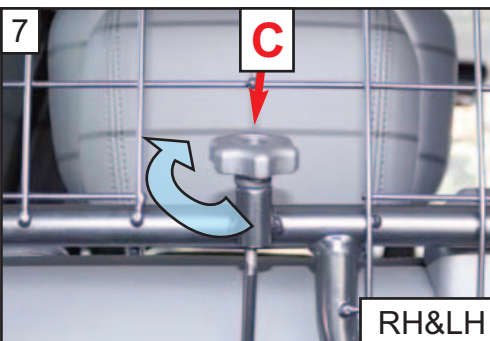

C

RH&LH



www.guardsmandogguards.co.uk



KIT



**Range Rover L460
(2022 onwards)
G1633D**

**VARIABLE BOOT DIVIDER
FITTING INSTRUCTION**

CAN ONLY BE USED IN
CONJUNCTION WITH
'GUARDSMAN'

**Range Rover L460
(2022 onwards)
G1633D**



1
Loosen lower hooks!
Untere Haken lösen!

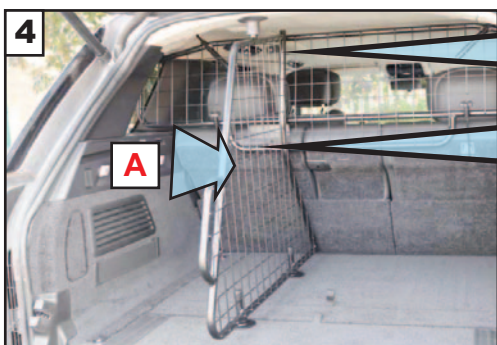
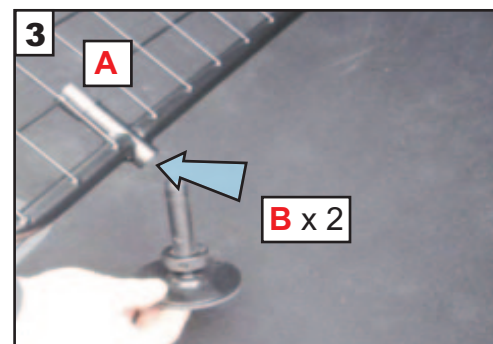
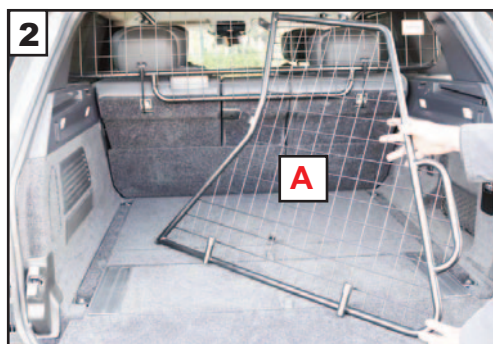

5
'C' Grips on opposite side of mesh.
'C' Griffe auf der gegenüberliegenden
Seite des Netzes

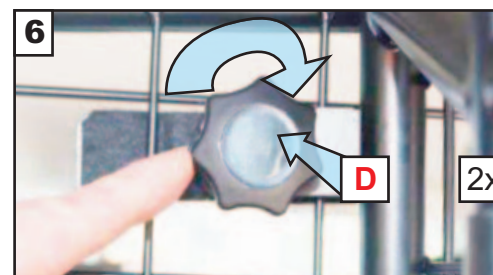

6
**! Do Not fully tighten !
! Nicht fest anziehen !**

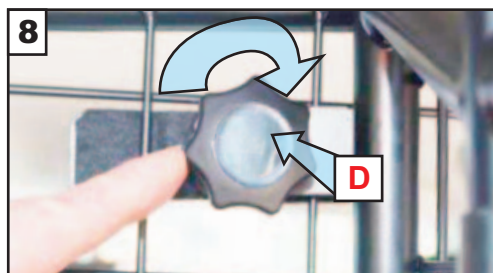
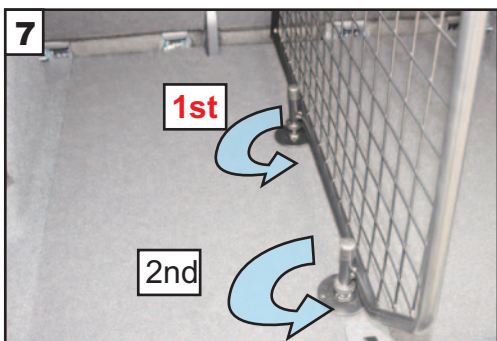

8
**! Fully tighten !
! Fest anziehen !**



**Tighten all fixings
Ziehen Sie alle Befestigungen fest**

**VARIABLER
KOFFERRAUMTEILER
MONTAGEANLEITUNG**

KANN NUR IN VERBINDUNG
MIT VERWENDET WERDEN
'GUARDSMAN'

**Range Rover L460
Hundegitter
(ab 2022)
G1633**

www.guardsmandogguards.co.uk



G1633D v.1 10/22